

DIN 2080, BALANCED CHUCK BODY, FOR MILLING CUTTERS (WELDON)  
ACCORDING TO DIN 1835 B AND DIN 6535 HB. SUPPLIED WITH  
TIGHTENING...

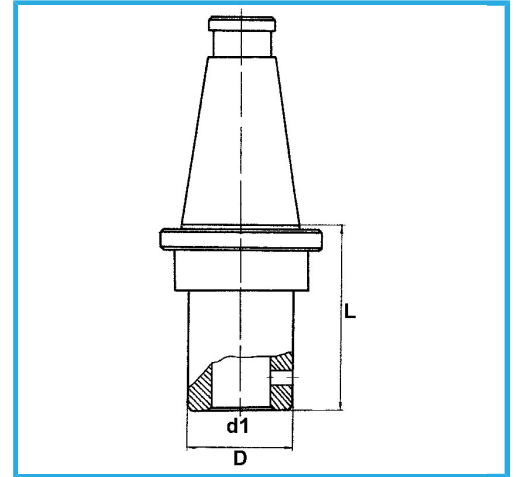

ISO	40
d1 - h6	6 mm
D	25 mm
L	50 mm
Gross weight	0,92 kg
EAN Code	8012667195861



Box



Grounded



18Ni  
CrMo5

-