

DIN 2080, CON CUERPO EQUILIBRADO, PARA FRESAS (WELDON)
SEGÚN DIN 1835 B Y DIN 6535 HB. SE SUMINISTRA CON TORNILLO
DE...

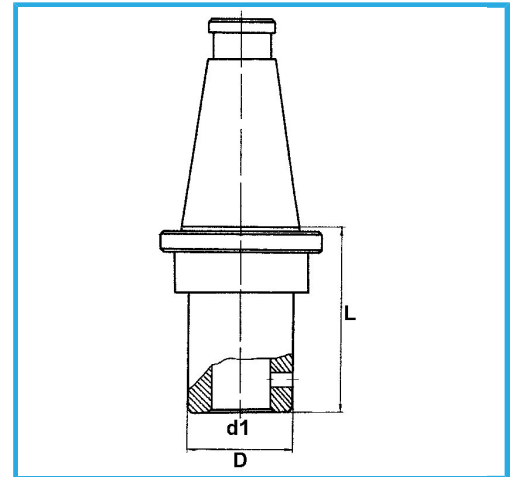

€140,00



ISO	50
d1 - h6	6 mm
D	25 mm
L	50 mm
Peso bruto	2,84 kg
Codigo de barras	8012667193041



Caja



Rectificado

18Ni
CrMo5