

DIN 2080, AUSGEWUCHTETES SPANNFUTTERGEHÄUSE, FÜR FRÄSER
(WELDON) NACH DIN 1835 B UND DIN 6535 HB. LIEFERUNG MIT...

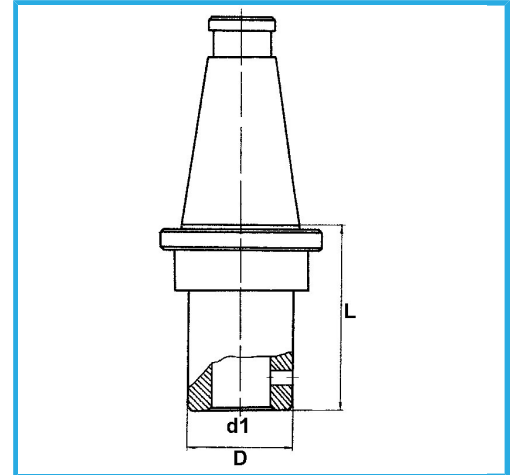

| | |
|---------------|---------------|
| ISO | 40 |
| d1 - h6 | 8 mm |
| D | 28 mm |
| L | 50 mm |
| Bruttogewicht | 0,94 kg |
| EAN-Code | 8012667195878 |



Box



Korrigiert



18Ni
CrMo5

-