

DIN 2080, AUSGEWUCHTETES SPANNFUTTERGEHÄUSE, FÜR FRÄSER
(WELDON) NACH DIN 1835 B UND DIN 6535 HB. LIEFERUNG MIT...

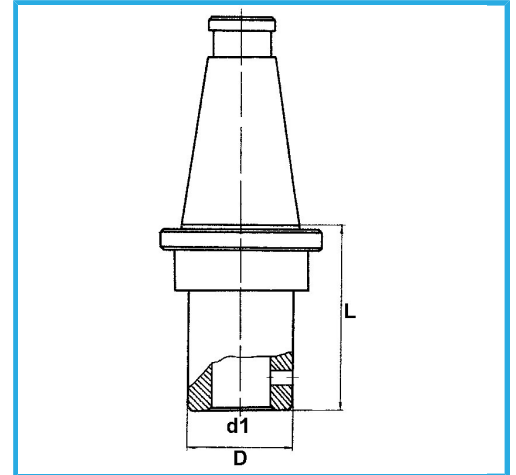

ISO	50
d1 - h6	8 mm
D	28 mm
L	50 mm
Bruttogewicht	2,99 kg
EAN-Code	8012667193072



Box



Korrigiert



18Ni
CrMo5

-