

DIN 2080, CORPO MANDRINO BILANCIATO, PER FRESE (WELDON)
SECONDO NORMA DIN 1835 B E DIN 6535 HB. FORNITO CON VITE DI
SERRAGGIO....

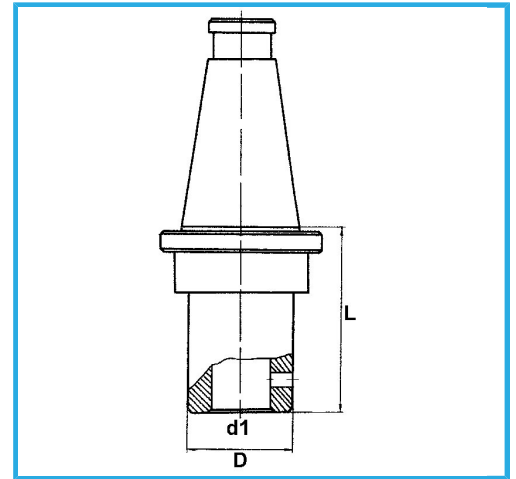

€140,00



| | |
|------------|---------------|
| ISO | 50 |
| d1 - h6 | 8 mm |
| D | 28 mm |
| L | 50 mm |
| Peso lordo | 2,99 kg |
| Codice EAN | 8012667193072 |



Scatola



Rettificato



18Ni
CrMo5