

DIN 2080, AUSGEWUCHTETES SPANNFUTTERGEHÄUSE, FÜR FRÄSER
(WELDON) NACH DIN 1835 B UND DIN 6535 HB. LIEFERUNG MIT...

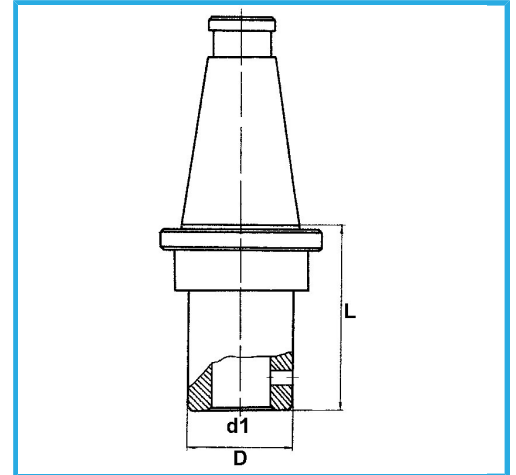

ISO	40
d1 - h6	12 mm
D	42 mm
L	50 mm
Bruttogewicht	1,14 kg
EAN-Code	8012667195922



Box



Korrigiert



18Ni
CrMo5

-