

DIN 2080, CORPO MANDRINO BILANCIATO, PER FRESE (WELDON)
SECONDO NORMA DIN 1835 B E DIN 6535 HB. FORNITO CON VITE DI
SERRAGGIO....

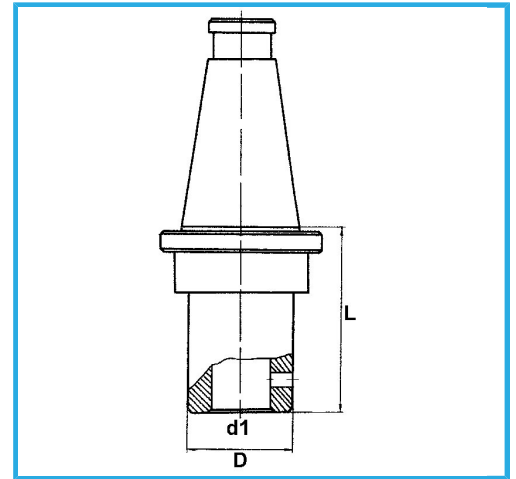

€129,00



ISO	40
d1 - h6	16 mm
D	48 mm
L	63 mm
Peso lordo	1,38 kg
Codice EAN	8012667195953



Scatola



Rettificato



18Ni
CrMo5