

DIN 2080, AUSGEWUCHTETES SPANNFUTTERGEHÄUSE, FÜR FRÄSER
(WELDON) NACH DIN 1835 B UND DIN 6535 HB. LIEFERUNG MIT...

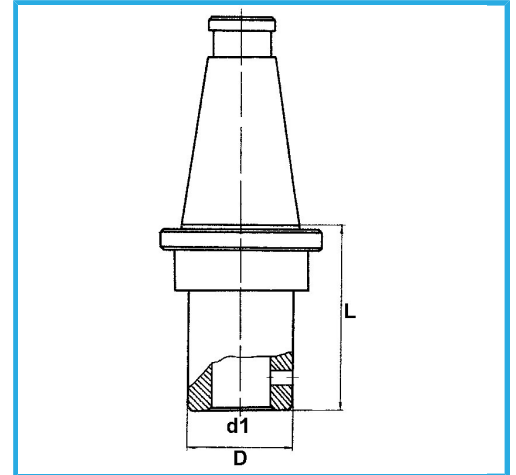

ISO	50
d1 - h6	16 mm
D	48 mm
L	50 mm
Bruttogewicht	4,06 kg
EAN-Code	8012667193188



Box



Korrigiert



18Ni
CrMo5

-