

DIN 2080, BALANCED CHUCK BODY, FOR MILLING CUTTERS (WELDON)  
ACCORDING TO DIN 1835 B AND DIN 6535 HB. SUPPLIED WITH  
TIGHTENING...

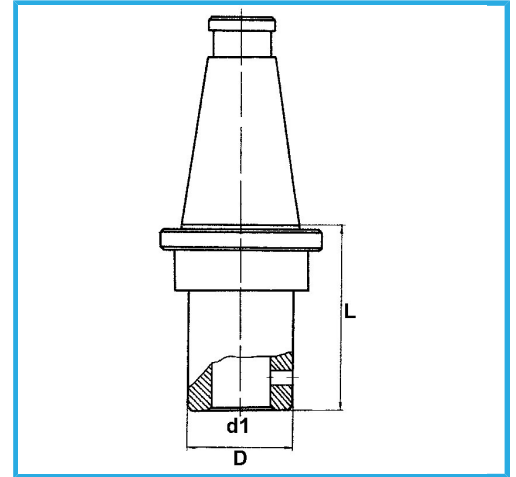

ISO	50
d1 - h6	20 mm
D	52 mm
L	63 mm
Gross weight	2,00 kg
EAN Code	8012667195465



Box



Grounded



18Ni  
CrMo5

-