

DIN 2080, AUSGEWUCHTETES SPANNFUTTERGEHÄUSE, FÜR FRÄSER
(WELDON) NACH DIN 1835 B UND DIN 6535 HB. LIEFERUNG MIT...

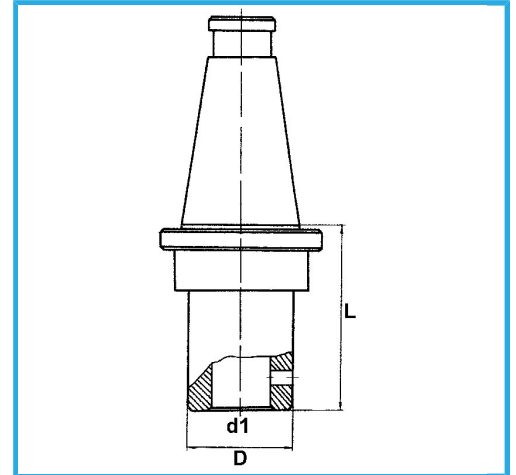

ISO	40
d1 - h6	25 mm
D	65 mm
L	100 mm
Bruttogewicht	2,24 kg
EAN-Code	8012667196028



Box



Korrigiert



18Ni
CrMo5

-