

DIN 2080, AUSGEWUCHTETES SPANNFUTTERGEHÄUSE, FÜR FRÄSER  
(WELDON) NACH DIN 1835 B UND DIN 6535 HB. LIEFERUNG MIT...

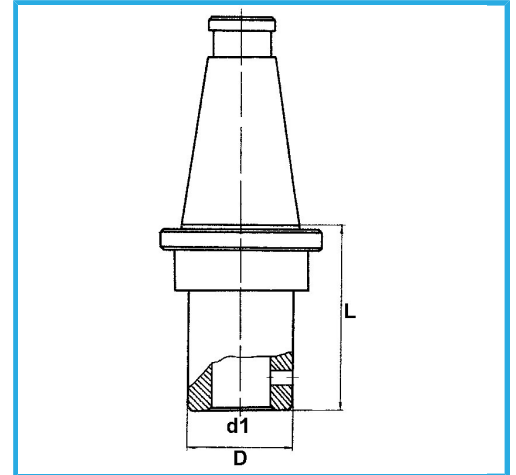

ISO	50
d1 - h6	25 mm
D	65 mm
L	80 mm
Bruttogewicht	4,76 kg
EAN-Code	8012667187583



Box



Korrigiert



18Ni  
CrMo5

-