

DIN 2080, AUSGEWUCHTETES SPANNFUTTERGEHÄUSE, FÜR FRÄSER
(WELDON) NACH DIN 1835 B UND DIN 6535 HB. LIEFERUNG MIT...

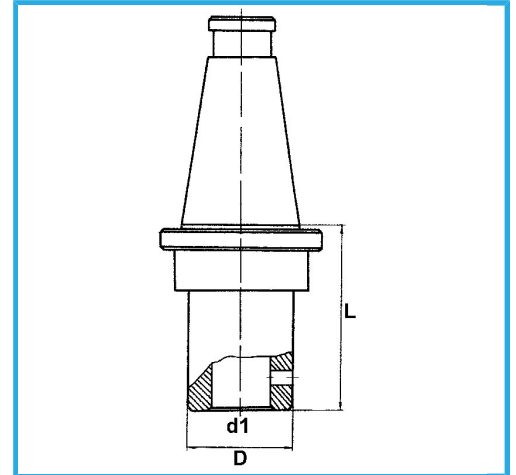

ISO	50
d1 - h6	32 mm
D	72 mm
L	80 mm
Bruttogewicht	4,16 kg
EAN-Code	8012667187606



Box



Korrigiert



18Ni
CrMo5

-