

DIN 2080, CORPO MANDRINO BILANCIATO, PER FRESE (WELDON)
SECONDO NORMA DIN 1835 B E DIN 6535 HB. FORNITO CON VITE DI
SERRAGGIO....

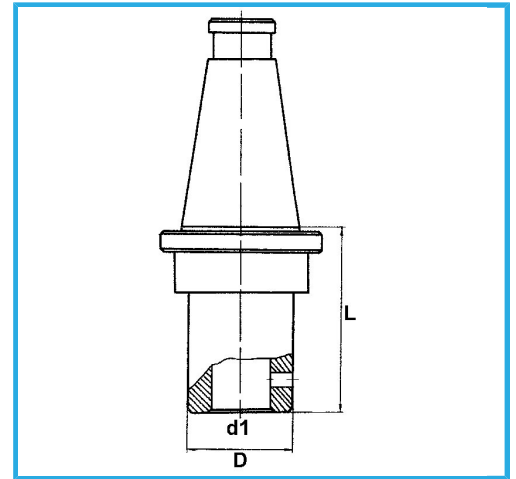

€166,00



ISO	50
d1 - h6	40 mm
D	90 mm
L	90 mm
Peso lordo	5,23 kg
Codice EAN	8012667195472



Scatola



Rettificato



18Ni
CrMo5