

DIN 2080, AUSGEWUCHTETES SPANNFUTTERGEHÄUSE, FÜR  
ZYLINDRISCHE SCHAFTFRÄSER NACH DIN 481, FÜR FRÄSER MIT..

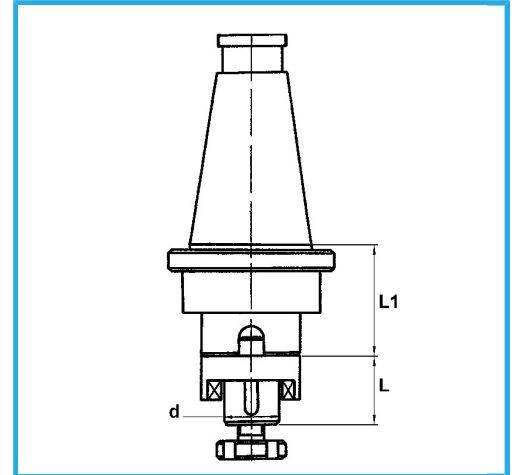

ISO	50
d - h6	40 mm
L	41 mm
L1	40 mm
Bruttogewicht	5,20 kg
EAN-Code	8012667008369



Box



Korrigiert



18Ni  
CrMo5

-