

DIN 2080, CORPO MANDRINO BILANCIATO, PER FRESE CILINDRICHE FRONTALI SECONDO NORMA DIN 481, PER FRESE CON SCANALATURA...

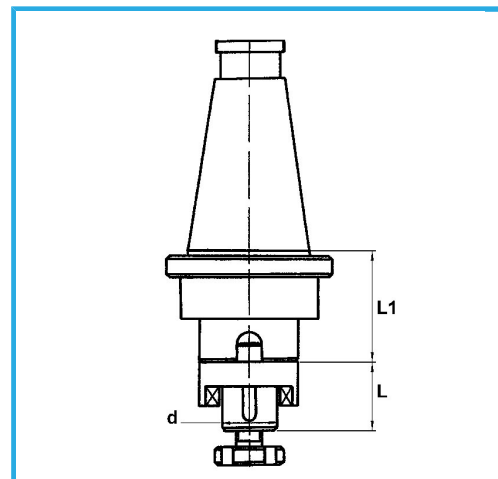

€182,00



ISO	50
d - h6	40 mm
L	41 mm
L1	40 mm
Peso lordo	5,20 kg
Codice EAN	8012667008369



Scatola



Rettificato



18Ni  
CrMo5