

DIN 228/A PARA FRESAS CILÍNDRICAS SEGÚN DIN 481, PARA FRESAS
CON RANURA LONGITUDINAL DIN 1880 Y PARA FRESAS DE...

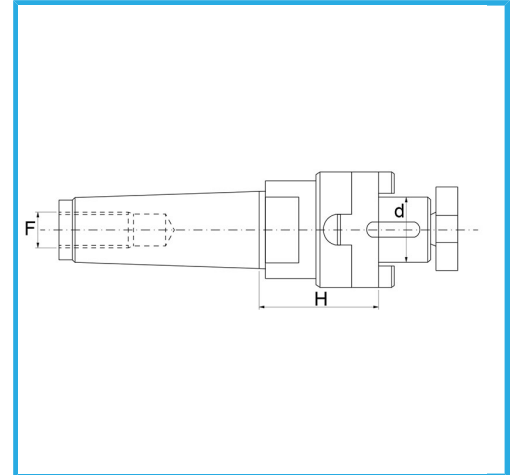

€102,00



d - h6	16 mm
Cono mordazas	3
F	M 12
H	40 mm
Peso bruto	0,66 kg
Codigo de barras	8012667179601



Caja



Rectificado



18Ni
CrMo5

-