

DIN 228/A PER FRESE CILINDRICHE FRONTALI SECONDO NORMA DIN 481, PER FRESE CON SCANALATURA LONGITUDINALE DIN 1880 E PER FRESE AD...

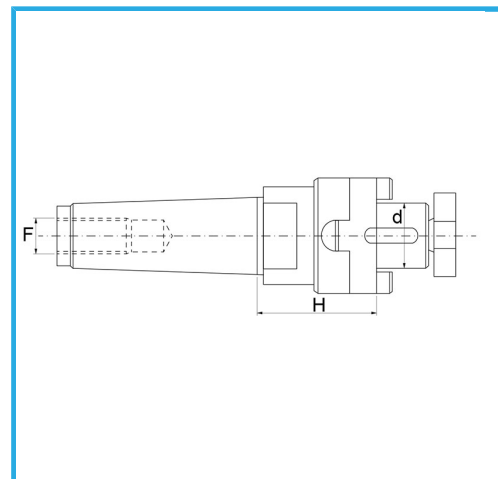

€102,00



d - h6	16 mm
Cono morse	4
F	M 16
H	55 mm
Peso lordo	1,06 kg
Codice EAN	8012667179632



Scatola



Rettificato

18Ni
CrMo5

-