

DIN 228/A FÜR ZYLINDRISCHE SCHAFTFRÄSER NACH DIN 481, FÜR
FRÄSER MIT LÄNGSNUT DIN 1880 UND FÜR...

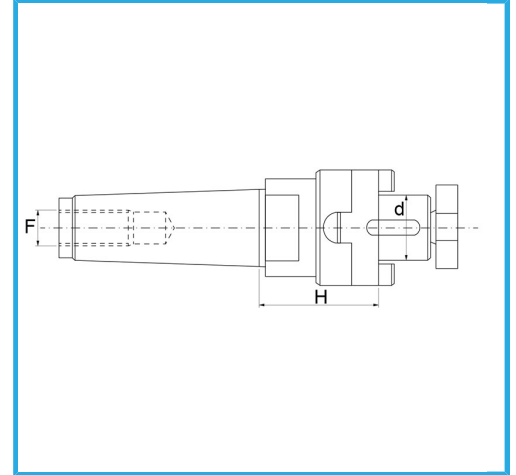

d - h6	22 mm
konische Schraubstücke	3
F	M 12
H	50 mm
Bruttogewicht	0,72 kg
EAN-Code	8012667179618



Box



Korrigiert



18Ni
CrMo5

-