

DIN 228/A FÜR ZYLINDRISCHE SCHAFTFRÄSER NACH DIN 481, FÜR  
FRÄSER MIT LÄNGSNUT DIN 1880 UND FÜR...

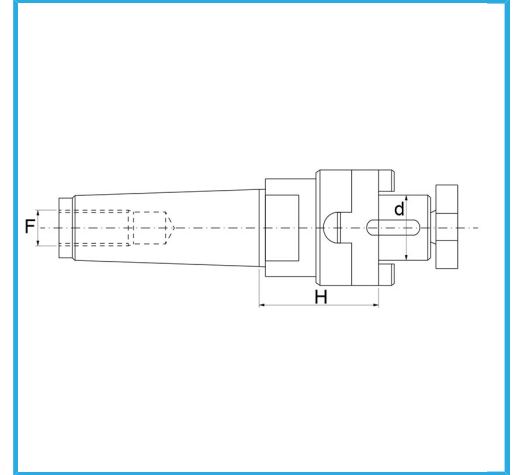

d - h6	27 mm
konische Schraubstücke	4
F	M 16
H	55 mm
Bruttogewicht	1,25 kg
EAN-Code	8012667179656



Box



Korrigiert



18Ni  
CrMo5

-