

DIN 228/A PER FRESE CILINDRICHE FRONTALI SECONDO NORMA DIN 481, PER FRESE CON SCANALATURA LONGITUDINALE DIN 1880 E PER FRESE AD...

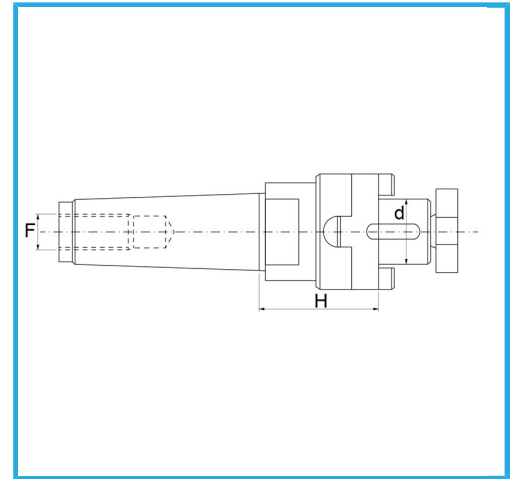

€102,00



d - h6	27 mm
Cono morse	4
F	M 16
H	55 mm
Peso lordo	1,25 kg
Codice EAN	8012667179656



Scatola



Rettificato



18Ni
CrMo5

-