

DIN 228/A, PER IL MONTAGGIO DI UTENSILI CON GAMBO CILINDRICO SU PINZE DIN 6499 (ER). FORNITO CON GHIERA DI SERRAGGIO.

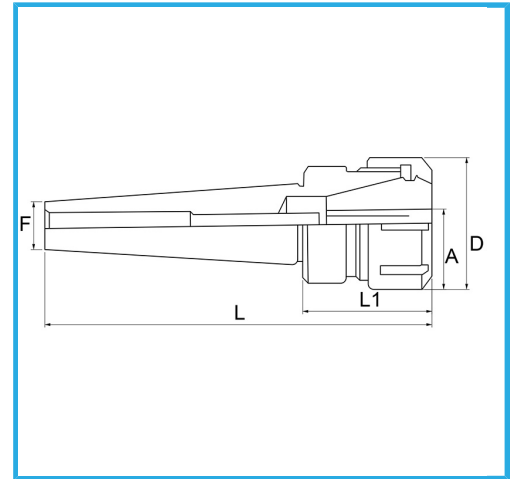

€96,50



Pinze	ER 32
D	50 mm
L	146 mm
L1	60 mm
F	M 12
A	3 / 20 mm
Peso lordo	0,63 kg
Codice EAN	8012667140168



Scatola

**18Ni
CrMo5** -



Rettificato