

CONSISTING OF EXTERNAL THREADING TOOL (1 PC), M3.5 X 12MM
SPARE SCREW (1 PC), 2.5MM HEX WRENCH (1 PC), T15 TORX
WRENCH (1 PC)...

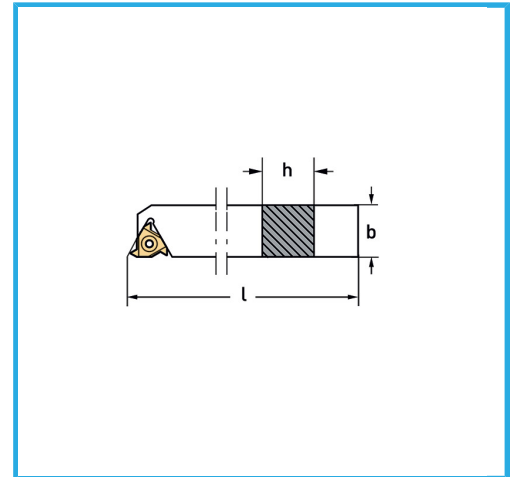
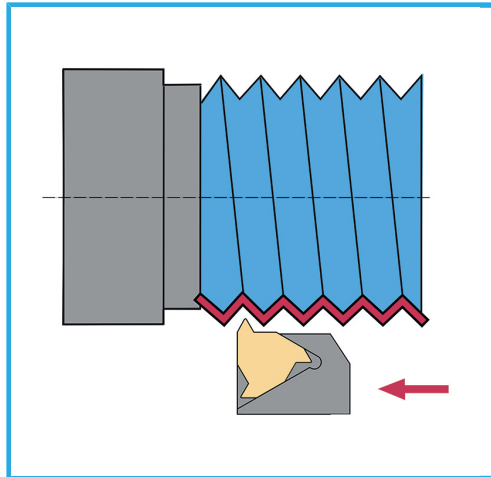

Ext. tool holder

Insert

Torx key

Screw

b

l

h

Gross weight

EAN Code

SER20

16ER...

T15

M3,5 x 12 mm

20 mm

20 mm

125 mm

0,82 kg

8012667252656



Satin



Nickel
plated



External



15 Pcs



Carrying
case