

BESTEHEND AUS: 1 STK WERKZEUG FÜR AUSSENANWENDUNG; 1 STK SCHRAUBE: M3,5 X 12MM; 1 STK SECHSKANTSCHLÜSSEL: 2,5MM; 1 STK..

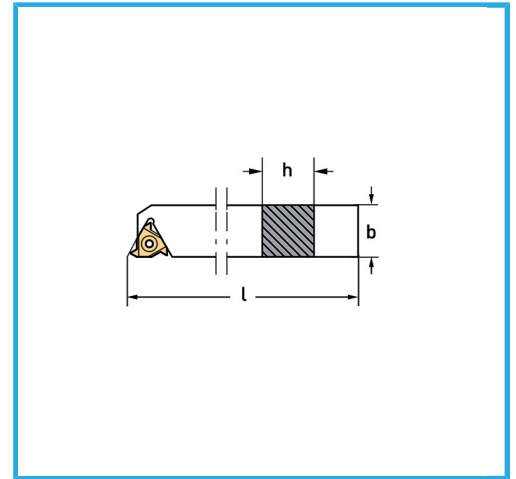
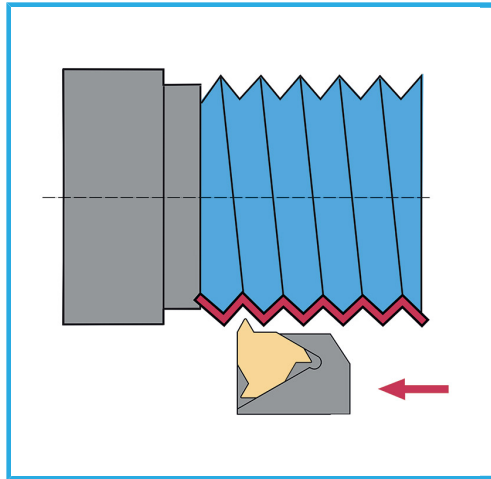

Werkzeuge für den extern

Einsatz

Torx-Schlüssel

Schraube

b

l

h

Bruttogewicht

EAN-Code

SER25

16ER...

T15

M3,5 x 12 mm

25 mm

25 mm

150 mm

1,19 kg

8012667260613



Satiniert



Vernickelt



Extern



15 Pcs



Koffer