

BESTEHEND AUS: 1 STK WERKZEUG FÜR INNENANWENDUNG 1 STK
SCHRAUBE: M3,5 X 12MM 1 STK SECHSKANTSCHLÜSSEL: 2,5MM 1
STK...

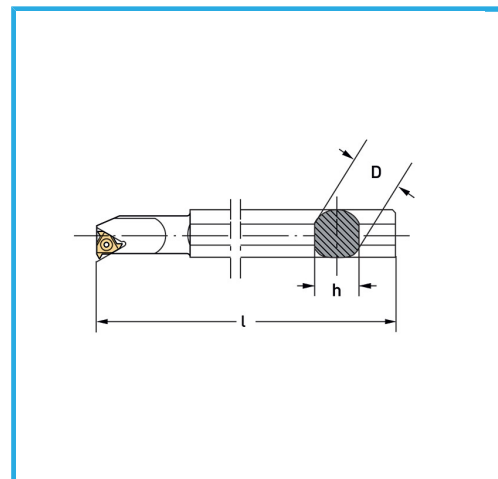
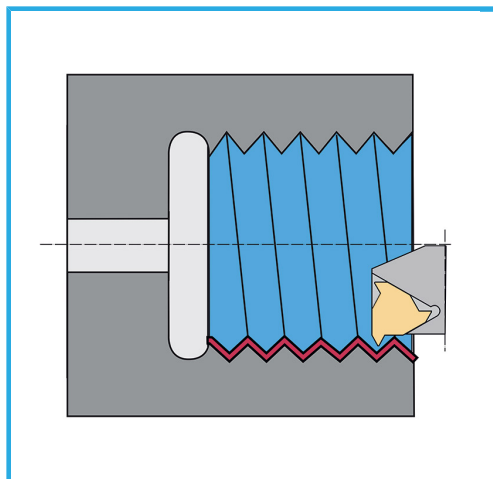

Werkzeuge für den Innenbereich

Einsatz

Torx-Schlüssel

Schraube

D

h

l

Bruttogewicht

EAN-Code

SNR25

16IR...

T15

M3.5 x 12 mm

25 mm

23 mm

200 mm

1,15 kg

8012667260620



Satiniert



Vernickelt



Extern



15 Pcs



Koffer