

MIT MUFFENANSCHLUSS, EMPFOHLEN FÜR DEN EINSATZ AN MASCHINEN MIT MITTLERER LEISTUNG.

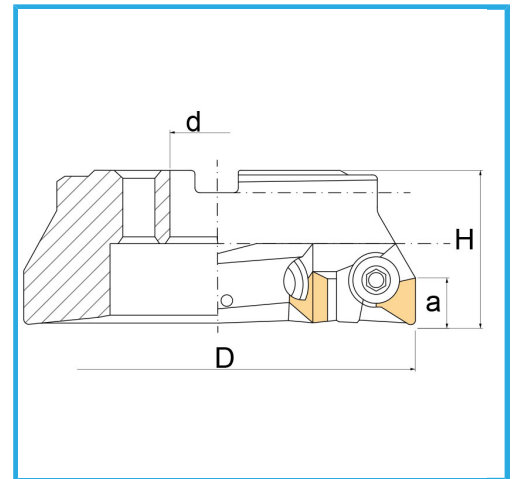

D	40 mm
H	40 mm
a	16 mm
d	16 mm
Z	3
Schraube	F256/644
Einsatz (nicht im Lieferumfang enthalten)	TPKN1603...
Bruttogewicht	0,27 kg
EAN-Code	8012667189860

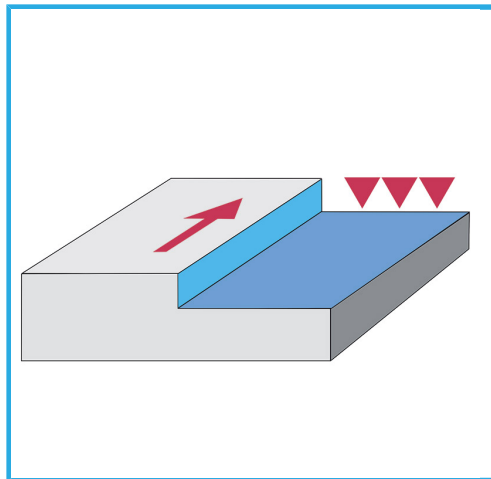

Box



Satiniert



Vernickelt



intern