

MIT MUFFENANSCHLUSS.

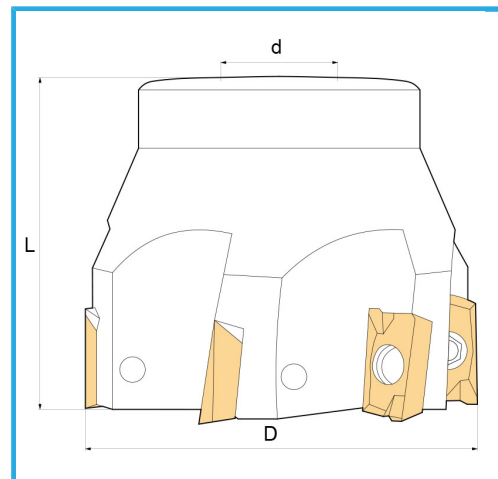

D	40 mm
L	40 mm
d	16 mm
Z	4
Schrauben	KV400
Einsatz (nicht im Lieferumfang enthalten)	APKT1604...
Bruttogewicht	0,22 kg
Verpackungsmaße	90x50x50 h mm
EAN-Code	8012667180973

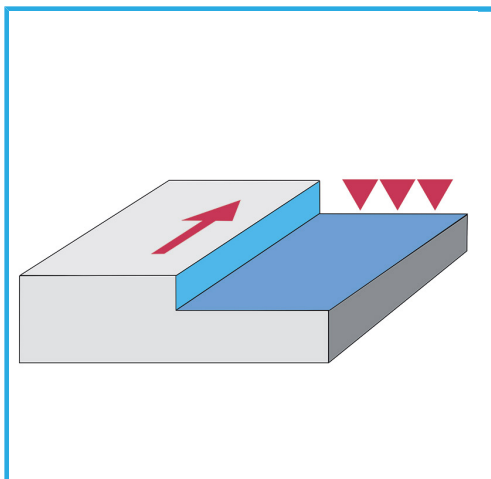

Box



Satiniert



Vernickelt



Extern