

MIT MUFFENANSCHLUSS.

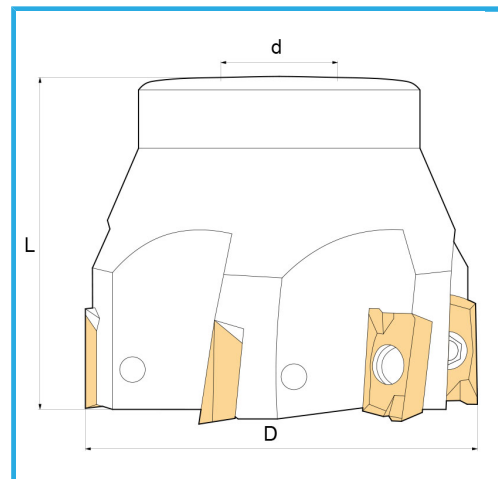

D	50 mm
L	45 mm
d	22 mm
Z	4
Schrauben	KV400
Einsatz (nicht im Lieferumfang enthalten)	APKT1604...
Bruttogewicht	0,38 kg
Verpackungsmaße	60x60x85 h mm
EAN-Code	8012667183929

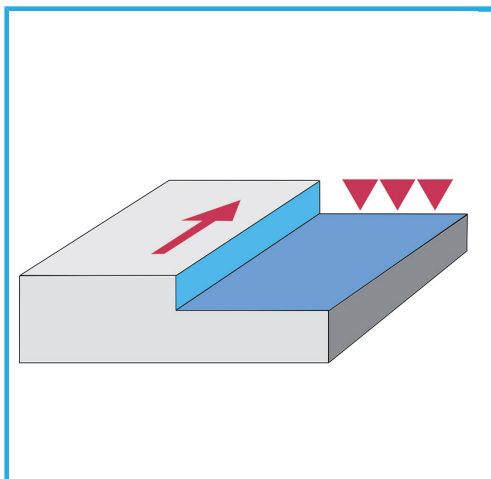

Box



Satiniert



Vernickelt



Extern