

CON CONEXIÓN DE MANGUITO.

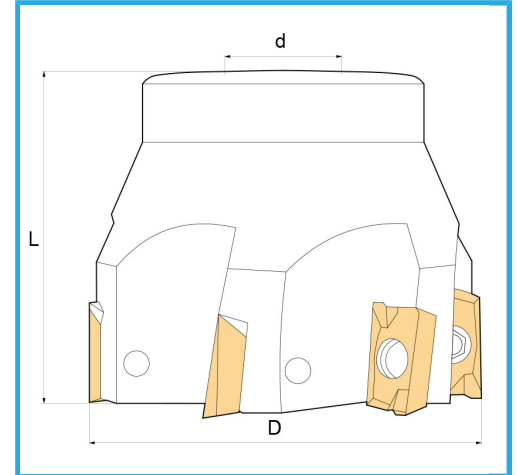

€196,00

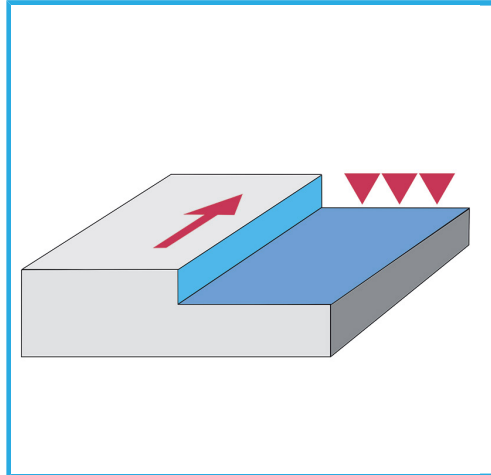

D	80 mm
L	50 mm
d	27 mm
Z	7
Tornillos	KV400
Paqueta (no incluida)	APKT1604...
Peso bruto	1,08 kg
Código de barras	8012667179670



Caja



Satinado



Niquelada



Externa