

CON CONEXIÓN DE MANGUITO, RECOMENDADO PARA USO EN MÁQUINAS CON POTENCIA MEDIA.

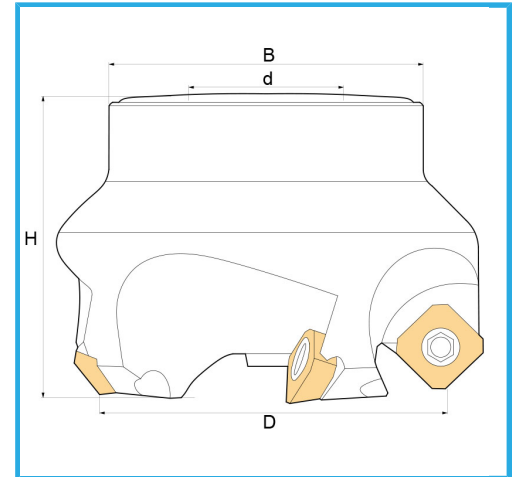

€135,00

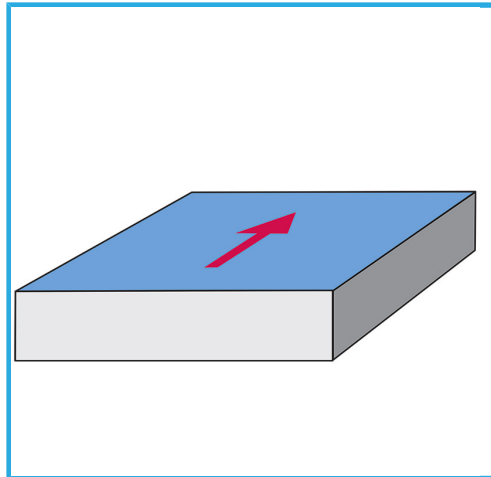

D	50 mm
H	48 mm
B	60 mm
d	22 mm
Z	4
Tornillos	KV500
Paquita (no incluida)	SEHX1204... / SEHT1204...
Peso bruto	0,67 kg
Codigo de barras	8012667183936



Caja



Satinado



Niquelada



Externa