

MIT MUFFENANSCHLUSS, EMPFOHLEN FÜR DEN EINSATZ AN MASCHINEN MIT MITTLERER LEISTUNG.

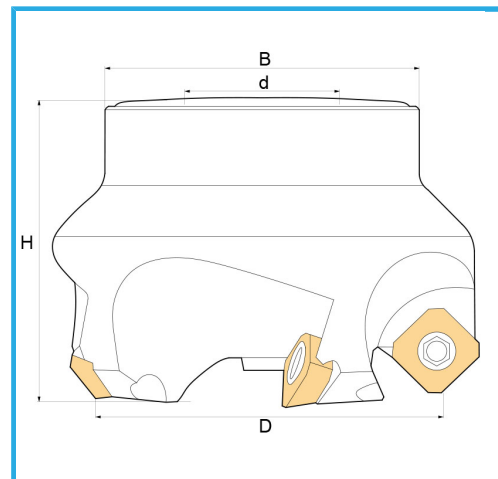

D	80 mm
H	50 mm
B	93 mm
d	27 mm
Z	5
Schrauben	KV500
Einsatz (nicht im Lieferumfang enthalten)	SEHX1204... / SEHT1204...
Bruttogewicht	1,07 kg
EAN-Code	8012667182571

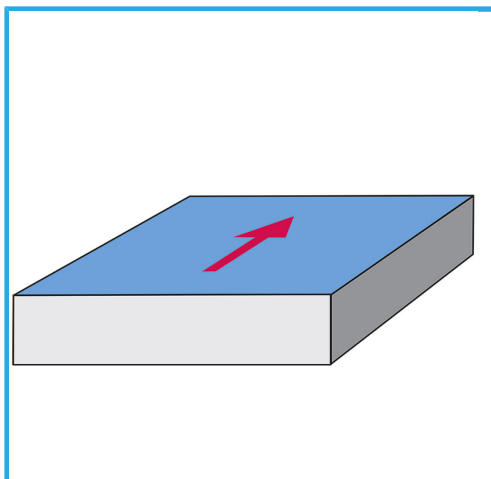

Box



Satiniert



Vernickelt



Extern