

WITH SLEEVE CONNECTION, RECOMMENDED FOR USE ON MACHINES WITH REDUCED POWER.

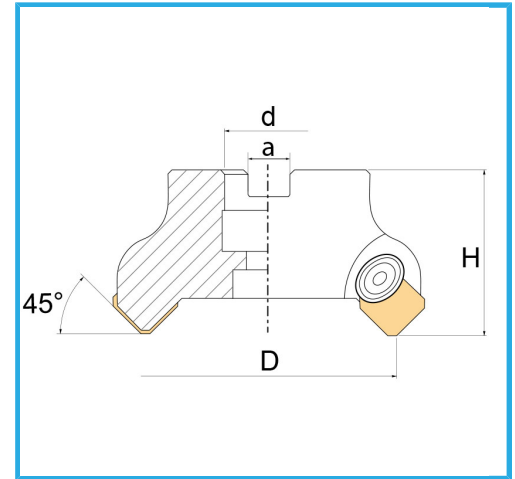

D	40 mm
H	48 mm
a	8,4 mm
d	16 mm
Z	3
Screw	VT00440
Insert base	WSSP
Insert (not included)	SEKN1203...
Gross weight	0,45 kg
EAN Code	8012667253172

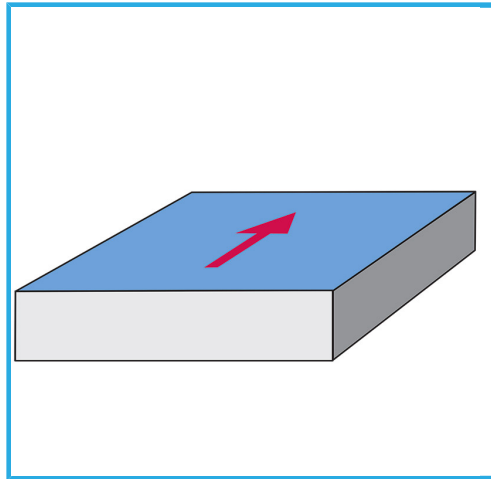

Box



Satin



Nickel
plated



External