

CON ATTACCO A MANICOTTO, CONSIGLIATO L'UTILIZZO SU MACCHINE
CON POTENZE RIDOTTE.

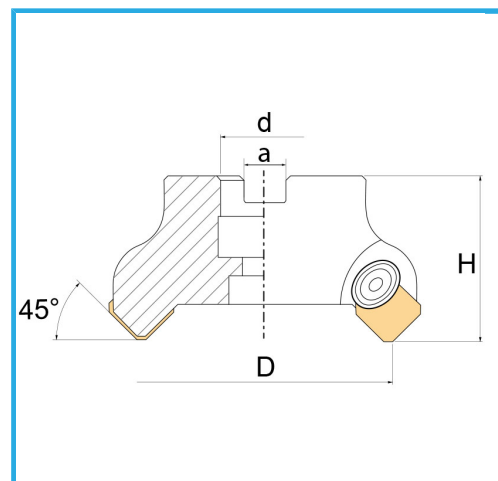

€154,00

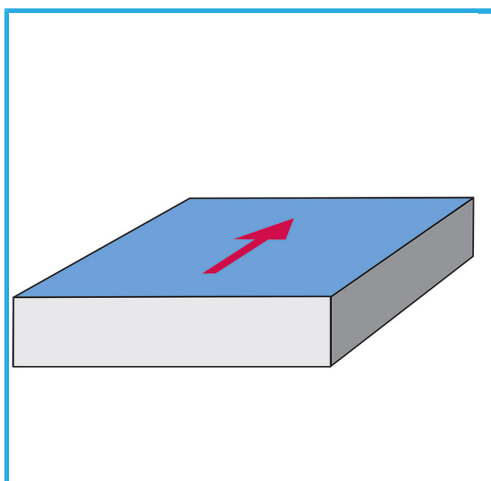

D	40 mm
H	48 mm
a	8,4 mm
d	16 mm
Z	3
Vite	VT00440
Sottoplacchetta	WSSP
Inserto (non incluso)	SEKN1203...
Peso lordo	0,45 kg
Codice EAN	8012667253172



Scatola



Satinata



Nichelata



Esterna