

WITH SLEEVE CONNECTION, RECOMMENDED FOR USE ON MACHINES WITH REDUCED POWER.

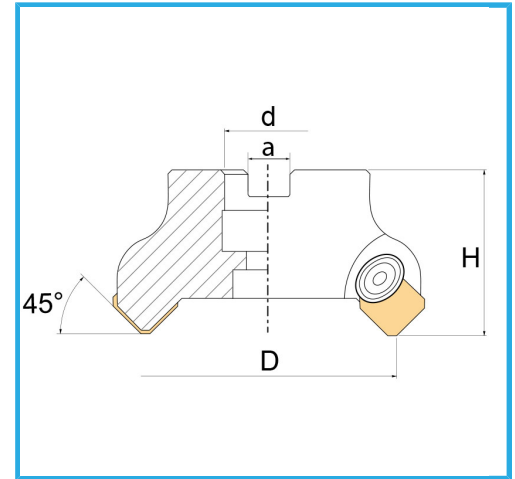

D	50 mm
H	48 mm
a	10,4 mm
d	22 mm
Z	4
Screw	VT00440
Insert base	WSSP
Insert (not included)	SEKN1203...
Gross weight	0,59 kg
EAN Code	8012667253189

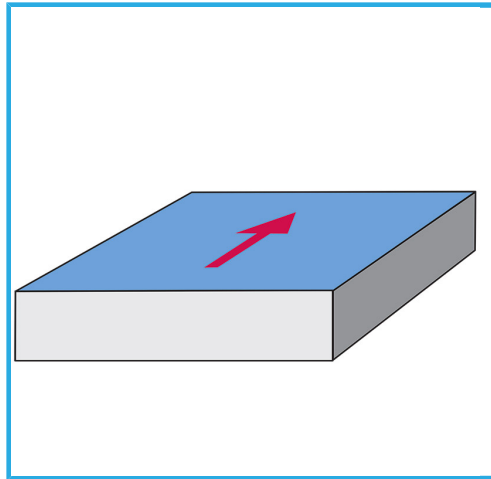

Box



Satin



Nickel plated



External