

MIT MUFFENANSCHLUSS, EMPFOHLEN FÜR DEN EINSATZ AN MASCHINEN MIT REDUZIERTER LEISTUNG.

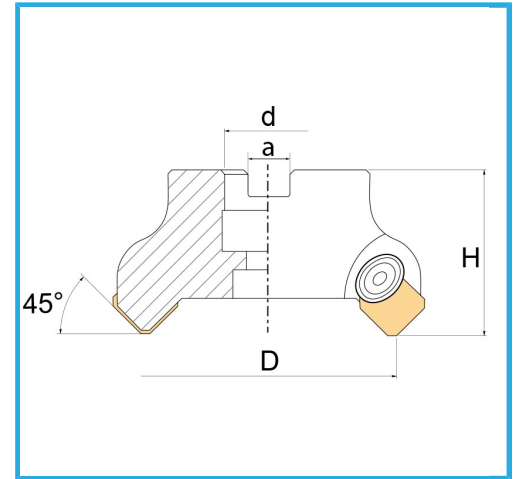

D	63 mm
H	48 mm
a	12,4 mm
d	22 mm
Z	5
Schraube	VT00440
Einlegeboden	WSSP
Einsatz (nicht im Lieferumfang enthalten)	SEKN1203...
Bruttogewicht	0,69 kg
EAN-Code	8012667253196

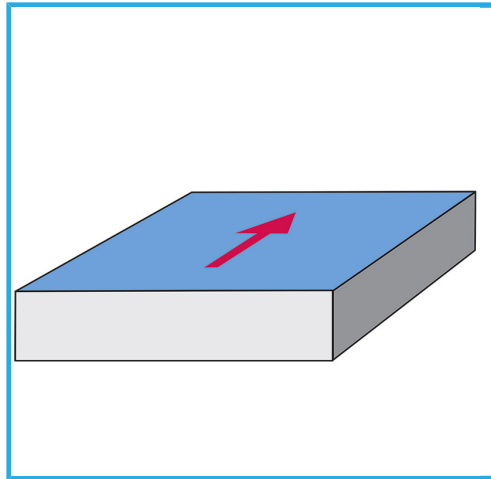

Box



Satiniert



Vernickelt



Extern