

CON CONEXIÓN DE MANGUITO, RECOMENDADO PARA USO EN MÁQUINAS CON POTENCIA REDUCIDA.

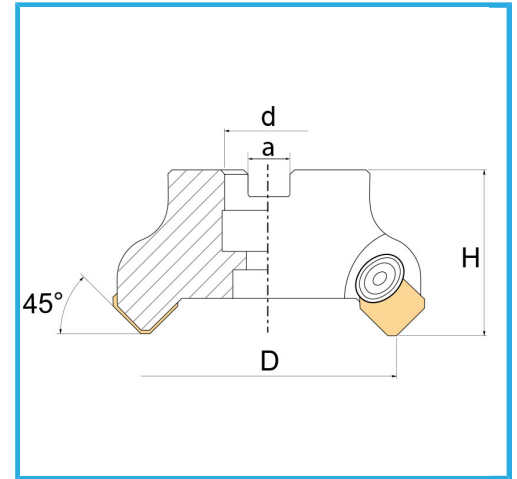

€172,00

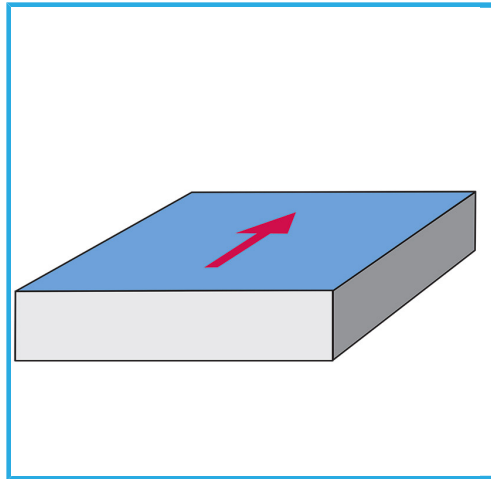

D	63 mm
H	48 mm
a	12,4 mm
d	22 mm
Z	5
Tornillo	VT00440
Base de plaquita	WSSP
Plaquita (no incluida)	SEKN1203...
Peso bruto	0,69 kg
Codigo de barras	8012667253196



Caja



Satinado



Niquelada



Externa