

POSITIVA.

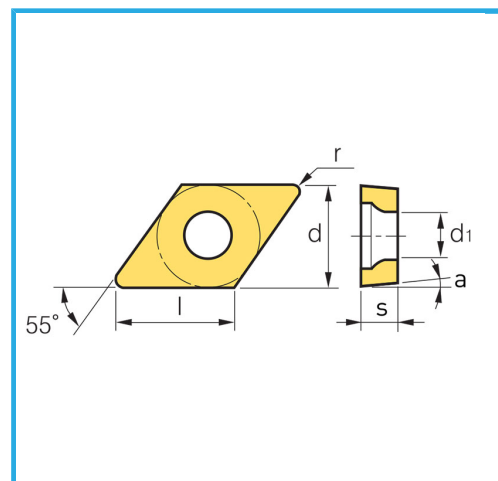

€7,60



Dimensioni	7 mm
d	6.35 mm
l	7.70 mm
s	2.38 mm
r	0.40 mm
d1	2.80 mm
a°	7°
Pack	10
Peso lordo	0,01 kg
Codice EAN	8012667188214



Scatola



-