

POSITIVA.

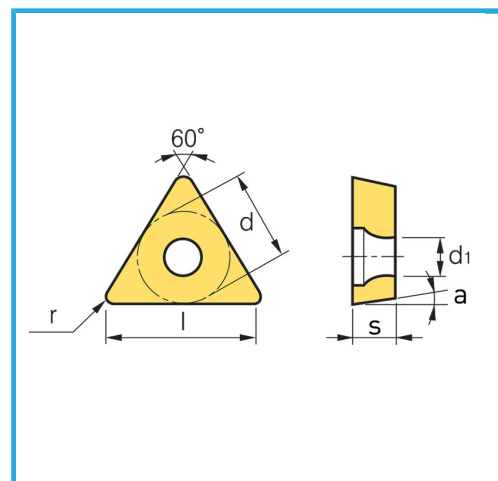

€7,70



Dimensioni	11 mm
d	6.35 mm
l	11.00 mm
s	2.38 mm
r	0.40 mm
d1	2.80 mm
a°	7°
Pack	10
Peso lordo	0,03 kg
Codice EAN	8012667007188



Scatola



-