

90°.

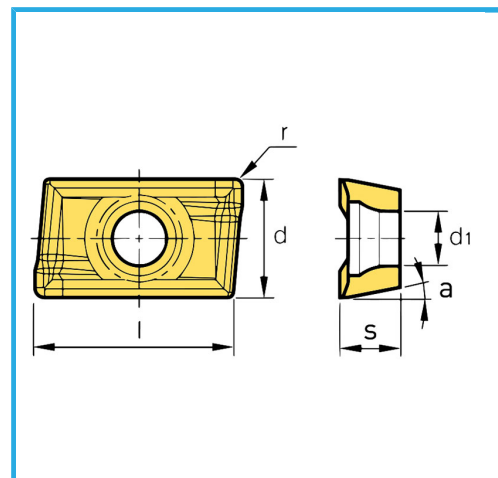

Abmessungen	15 mm
d	9.52 mm
l	14.5 mm
s	3.18 mm
r	0.80 mm
d1	4.50 mm
a°	15°
Pack	10
Bruttogewicht	0,01 kg
EAN-Code	8012667200763

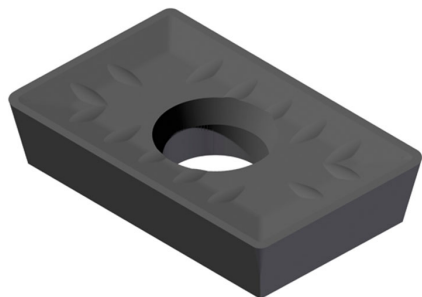

Box



-