

45°.

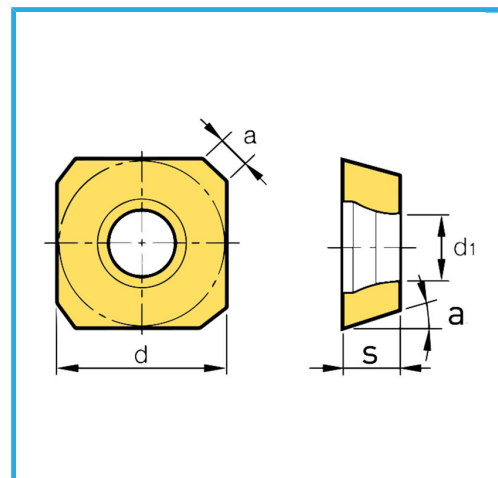

Abmessungen	12 mm
d	12.70 mm
a	1.80 mm
S	4.76 mm
d1	5.50 mm
a°	20°
Pack	10
Bruttogewicht	0,07 kg
EAN-Code	8012667256838



Box

