

ISO 2

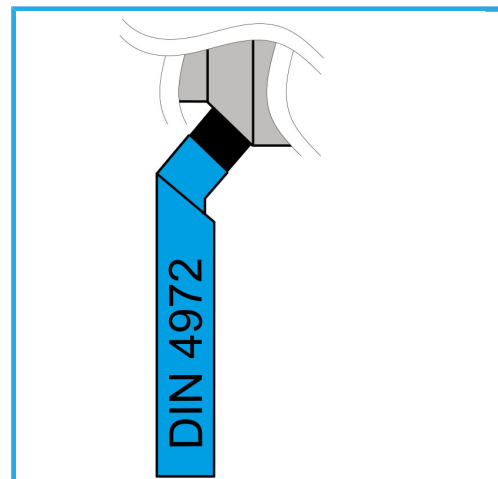

L	90 mm
b	10 mm
h	10 mm
Bruttogewicht	0,07 kg
EAN-Code	8012667007478

HM
P25

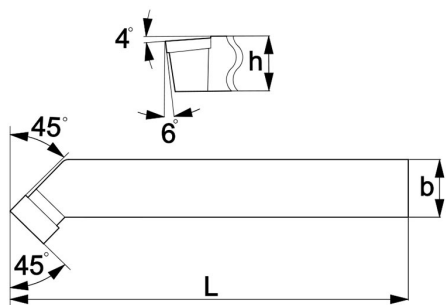

4972