

ISO 2

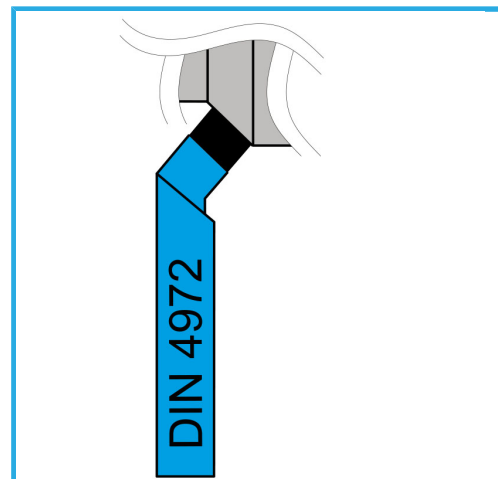

€6,60

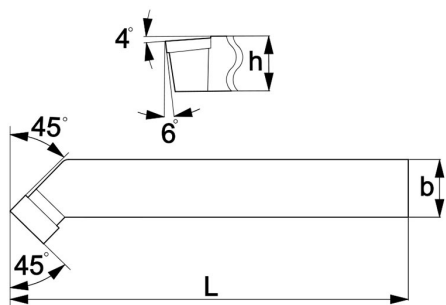

L	90 mm
b	10 mm
h	10 mm
Peso bruto	0,07 kg
Codigo de barras	8012667007478



4972