

ISO 2

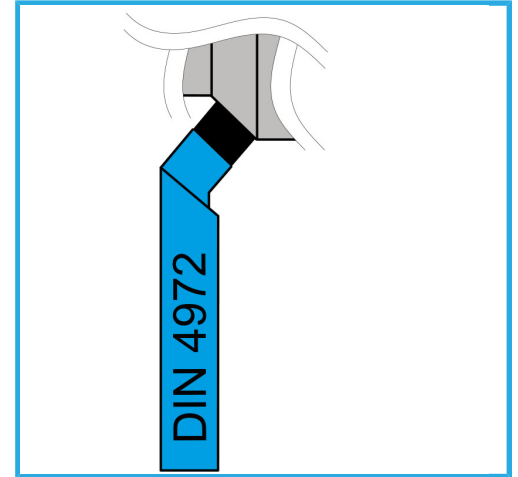

L	110 mm
b	16 mm
h	16 mm
Bruttogewicht	0,20 kg
EAN-Code	8012667008857

HM
P25

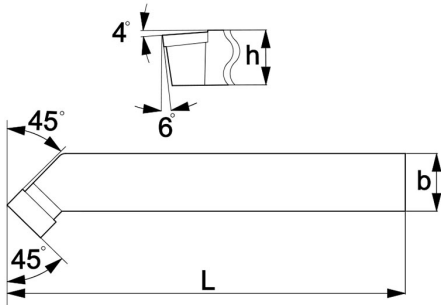

4972