

ISO 2

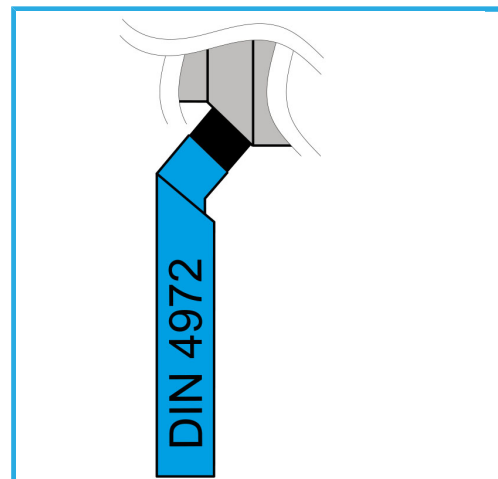

€8,70

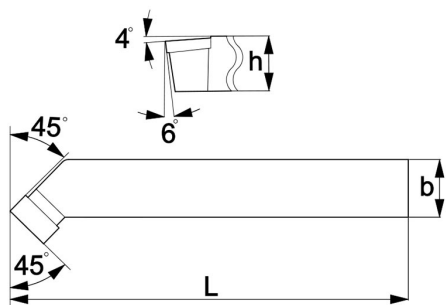

L	110 mm
b	16 mm
h	16 mm
Peso lordo	0,20 kg
Codice EAN	8012667007492



4972