

ISO 2

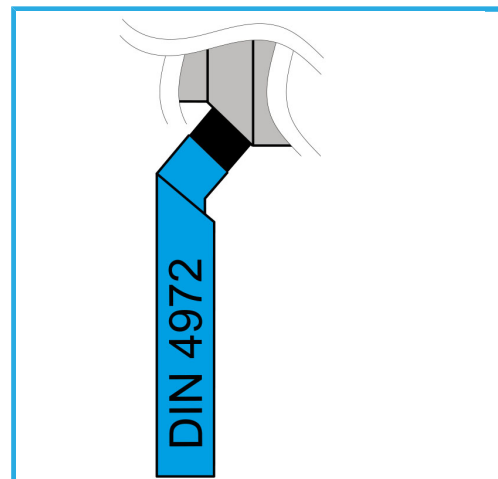

L	125 mm
b	20 mm
h	20 mm
Bruttogewicht	0,37 kg
EAN-Code	8012667008888

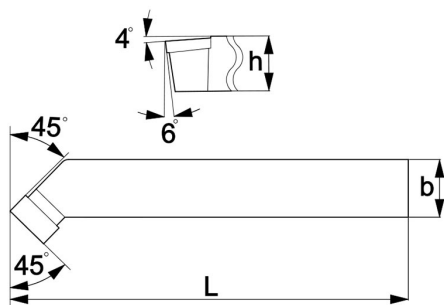

4972