

PARA AGUJEROS PASANTES.

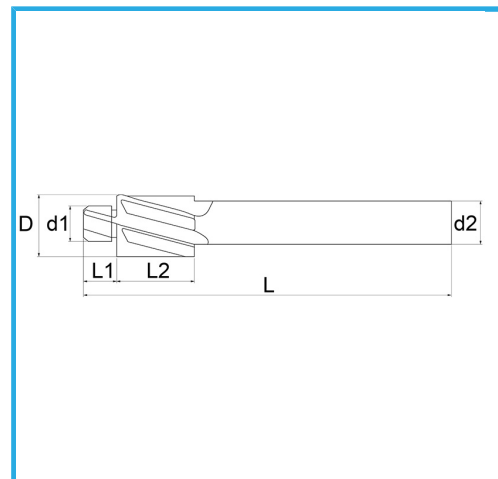

€15,30



Tornillos	M 4
D	8 mm
d1	4,5 mm
d2	5 mm
L1	5 mm
L2	14 mm
L	71 mm
Peso bruto	0,02 kg
Codigo de barras	8012667179908



Caja



HSS

-



TiN

-



Externa



DIN

373