

PARA AGUJEROS PASANTES.

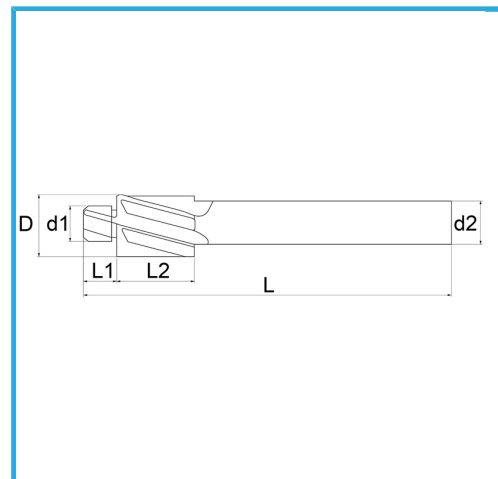

€17,40

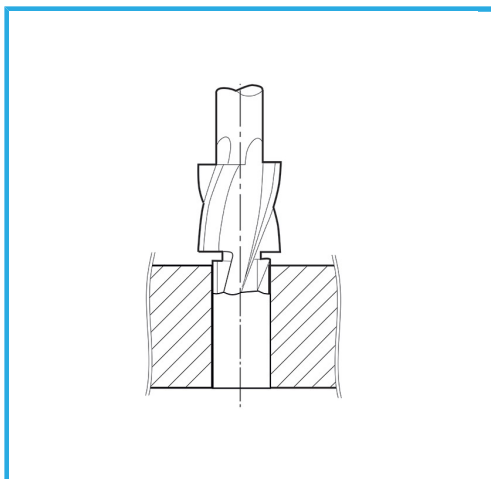

<b>Tornillos</b>	M 6
<b>D</b>	11 mm
<b>d1</b>	6,6 mm
<b>d2</b>	8 mm
<b>L1</b>	7 mm
<b>L2</b>	18 mm
<b>L</b>	80 mm
<b>Peso bruto</b>	0,03 kg
<b>Codigo de barras</b>	8012667182854



Caja



HSS

-



TiN

-



Externa



DIN

373