

PARA AGUJEROS PASANTES.

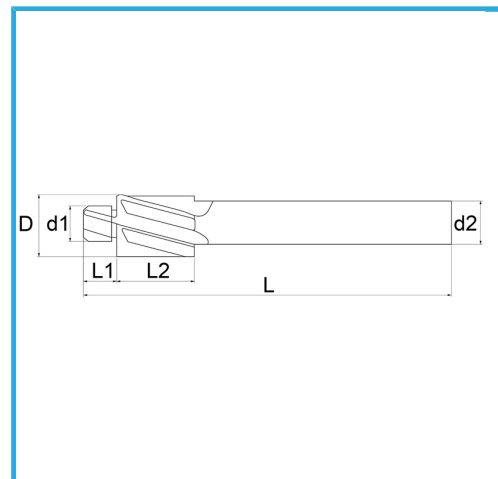

€26,60

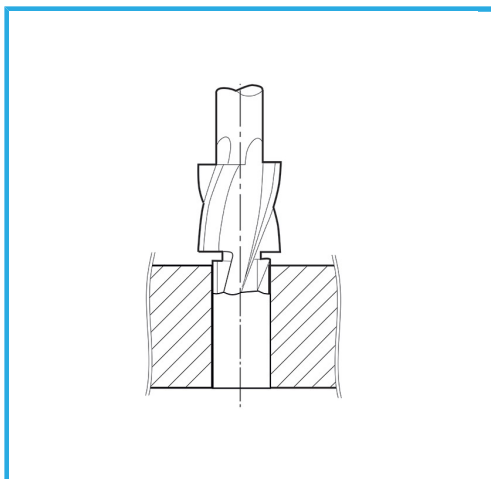

Tornillos	M 8
D	15 mm
d1	9 mm
d2	12,5 mm
L1	9 mm
L2	22 mm
L	100 mm
Peso bruto	0,09 kg
Codigo de barras	8012667179922



Caja



HSS

-



TiN

-



Externa



DIN

373