

REGULAR LENGTH WELDON SHANK CENTER CUTTING.

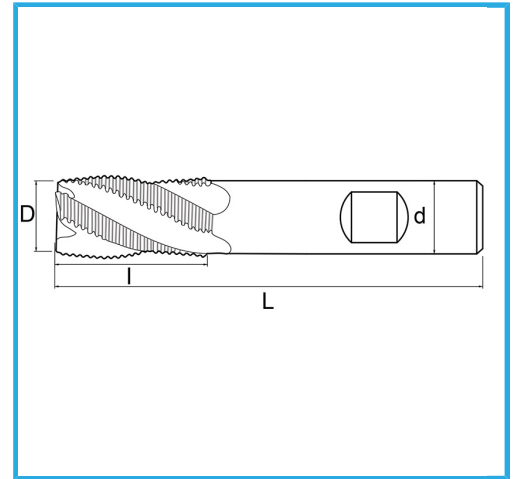

D	6 mm
d	6 mm
l	13 mm
Z	4
L	57 mm
Gross weight	0,01 kg
EAN Code	8012667217297



Box



External



844/B



HSS

-



TIN

-