

REGULAR LENGTH WELDON SHANK CENTER CUTTING.

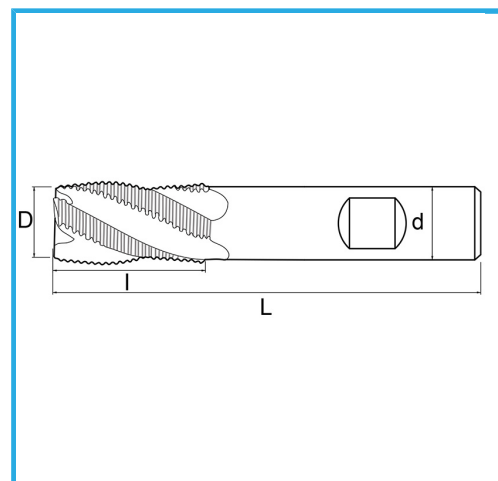

D	9 mm
d	10 mm
l	19 mm
Z	4
L	69 mm
Gross weight	0,04 kg
EAN Code	8012667237875



Box



External



844/B



HSS

-



TIN

-