

REGULAR LENGTH WELDON SHANK CENTER CUTTING.

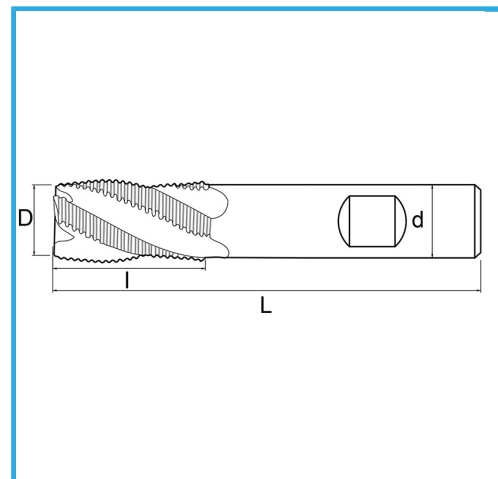

D	11 mm
d	12 mm
l	22 mm
Z	4
L	76 mm
Gross weight	0,06 kg
EAN Code	8012667237905



Box



External



844/B



HSS

-



TIN

-